

## INDEX OF DOCUMENTS HELD ON THE PUBLIC REGISTER FOR PPL 146

---

1. 11 August 1999 Grant of Licence  
Effective Date: 1 January 1999  
Expiry Date: 31 December 2019
  
2. 11 August 1999 Memorandum entering Petroleum Production Licence  
PPL 146 on the petroleum register  
  
Interests in the Licence are as follows:

|                                      | %     |
|--------------------------------------|-------|
| Santos Ltd                           | 40.70 |
| Delhi Petroleum Pty Ltd              | 20.21 |
| Boral Energy Resources Ltd           | 13.19 |
| Vamgas Pty Ltd                       | 8.51  |
| Gulf (Aust) Resources NL             | 4.75  |
| Bridge Oil Developments Pty Ltd      | 3.99  |
| Alliance Petroleum Australia Pty Ltd | 3.97  |
| Basin Oil NL                         | 2.10  |
| Reef Oil Pty Ltd                     | 1.97  |
| Santos Petroleum Pty Ltd             | 0.40  |
| Santos (BOL) Pty Ltd                 | 0.21  |
  
3. 19 August 1999 Gazettal of grant of PPL 146 published in SA Government  
Gazette dated 19 August 1999, Page 917.
  
4. 10 December 1999 Certificate of Registration on Change of Name dated 6  
October 1999:  
From: Gulf (Aust) Resources NL  
To: Novus Australia Resources NL
  
5. 10 December 1999 Memorandum entering change of company name on the  
Public Register
  
6. 13 March 2000 Certificate of Registration on Change of Name dated 24  
February 2000:  
From: Boral Energy Resources  
To: Origin Energy Resources Ltd
  
7. 13 March 2000 Memorandum entering change of company name on the  
Public Register.
  
8. 15 October 2002 Certificate of Registration on Change of Type and  
Conversion to a Proprietary Company dated 8 June  
2000:  
From: Basin Oil NL  
To: Basin Oil Pty Ltd
  
9. 15 October 2002 Memorandum entering change of company name on the  
Public Register.

10. 7 May 2004 Memorandum dated 7 May 2004 entering notation of adoption of the register for PELs 5&6 as part of the Commercial Register.
11. 23 July 2004 Memorandum entering notation of registrable dealing on the public register:
- DPPL Security dated 21 May 2004 between Delhi Petroleum Pty Ltd and Westpac Banking Corporation Ref:SA 2004-44
12. 23 November 2005 Notation of discharge of security and receipt of replacement security is entered on the public register.
13. 13 January 2006 Memorandum entering change of name on the public register:
- From: Novus Australia Resources NL  
To: Santos (NARNL Cooper) NL
14. 9 May 2006 Memorandum entering change of name on the public register:
- From: Santos (NARNL Cooper) NL  
To: Santos (NARNL Cooper) Pty Ltd
15. 15 February 2011 Memorandum entering notation of the following registrable dealing on the public register.
- Delhi Fixed and Floating Charge and Mortgage of JV Assets dated 29 September 2010 between Delhi Petroleum Pty Limited and Westpac Banking Corporation.  
Ref: SA 2011-15
16. 28 June 2012 Memorandum entering notation of the following registrable dealing on the public register.
- Royalty Deed dated 19 January 2012 between Delhi Petroleum Pty Ltd and Esso Australia Resources Pty Ltd.  
Ref: SA 2012-42
17. .9 August 2017 Certificate of Registration on Change of Company Name dated 29 June 2017.
- From: Origin Energy Resources Limited  
To: Lattice Energy Limited
18. 9 August 2017 Memorandum entering notation of change of company name on the public register.

19. 7 June 2018 Memorandum entering notation of the following registrable dealing on the public register:
- Deed of Variation dated 4 December 2015 between Santos Limited, Santos Petroleum Pty Ltd, Vamgas Pty Ltd, Santos (NARNL Cooper) Pty Ltd, Santos (BOL) Pty Ltd, Reef Oil Pty Ltd, Bridge Oil Developments Pty Limited, Basin Oil Pty Ltd, Alliance Petroleum Australia Pty Ltd, Origin Energy Resources Limited and Delhi Petroleum Pty Ltd  
Ref: SA 2018-18
20. 22 January 2020 Certificate of Registration on Change of Name dated 2 December 2019.
- From: Lattice Energy Limited  
To: Beach Energy (Operations) Limited
21. 22 January 2020 Memorandum entering notation of change of company name on the public register.
22. 27 November 2020 Memorandum entering notation of revision to security arrangements on the public register.

**Petroleum and Geothermal Energy Act 2000  
S.115**

**MEMORANDUM**

**PETROLEUM EXPLORTION LICENCE  
PEL 570**

**PETROLEUM RETENTION LICENCES**

**PRLs 14, 17, 18, 28, 29, 30, 31, 111, 112, 113, 114, 115, 131, 132, 133,  
134, 180, 181, 182, 191, 192, 193, 194, 195, 196, 197, 198, 199, 200,  
201, 202, 203, 204, 205 and 206**

**PETROLEUM PRODUCTION LICENCES**

**PPLs 6, 7, 8, 9, 10, 11, 12, 13, 14, 15, 16, 17, 18, 19, 20, 22, 23, 24, 25,  
26, 27, 29, 30, 31, 32, 33, 35, 36, 37, 38, 39, 40, 41, 42, 43, 44, 45, 46,  
47, 48, 51, 52, 53, 54, 55, 56, 57, 58, 59, 60, 61, 63, 64, 65, 66, 67, 68,  
69, 70, 72, 73, 74, 75, 76, 77, 78, 79, 80, 81, 83, 84, 86, 87, 88, 89, 90,  
91, 92, 94, 95, 98, 99, 100, 101, 102, 103, 104, 105, 106, 107, 108, 109,  
110, 111, 113, 114, 115, 116, 117, 118, 119, 120, 121, 122, 123, 124,  
125, 126, 127, 128, 129, 130, 131, 132, 133, 134, 135, 136, 137, 138,  
139, 140, 143, 144, 145, 146, 147, 148, 149, 150, 151, 152, 153, 154,  
155, 156, 158, 159, 160, 161, 162, 163, 164, 165, 166, 167, 172, 174,  
175, 176, 177, 178, 179, 180, 182, 187, 189, 190, 193, 194, 195, 196,  
201, 206, 225, 226, 227, 228, 229, 230, 231, 232, 233, 234, 235, 236,  
237, 238 and 252**

**SPECIAL FACILITIES LICENCE  
SFL 15**

**PIPELINE LICENCES  
PLs 2, 5, 9, 15, 17 and 20**

1. Notation of revision to security arrangements is hereby entered on the public register.
2. Effective 27 November 2020, future revisions to security arrangements for the above-mentioned licences will no longer be noted on the public register.

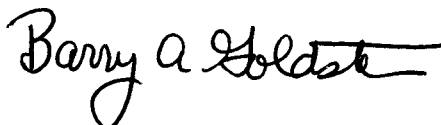

**BARRY A. GOLDSTEIN  
Executive Director  
Energy Resources Division  
Department for Energy and Mining  
Delegate of the Minister for Energy and Mining**

Date: 27 November 2020

Ref: F2020/000930

**Petroleum and Geothermal Energy Act 2000**  
**S.115**

**MEMORANDUM**

**PETROLEUM PRODUCTION LICENCES**

**PPLs 6, 7, 8, 9, 10, 11, 12, 13, 14, 15, 16, 17, 18, 19, 20, 22, 23, 24, 25, 26, 27, 29, 30, 31, 32, 33, 35, 36, 37, 38, 39, 40, 41, 42, 43, 44, 45, 46, 47, 48, 51, 52, 53, 54, 55, 56, 57, 58, 59, 60, 61, 63, 64, 65, 66, 67, 68, 69, 70, 72, 73, 74, 75, 76, 77, 78, 79, 80, 81, 83, 84, 86, 87, 88, 89, 90, 91, 92, 94, 95, 98, 99, 100, 101, 102, 103, 104, 105, 106, 107, 108, 109, 110, 111, 113, 114, 115, 116, 117, 118, 119, 120, 121, 122, 123, 124, 125, 126, 127, 128, 129, 130, 131, 132, 133, 134, 135, 136, 137, 138, 139, 140, 143, 144, 145, 146, 147, 148, 149, 150, 151, 152, 153, 154, 155, 156, 158, 159, 160, 161, 162, 163, 164, 165, 166, 167, 172, 174, 175, 176, 177, 178, 179, 180, 182, 187, 189, 190, 193, 194, 195, 196, 201, 228, 229, 230, 231, 232, 233, 234, 235, 236, 237 and 238**

**ASSOCIATED ACTIVITIES LICENCES**

**AALs 258, 259 and 263**

**PIPELINE LICENCES**

**PLs 2, 5, 9, 15 and 20**

1. Notation of change of company name:

From: Lattice Energy Limited  
To: Beach Energy (Operations) Limited

is hereby entered on the public registers.



**BARRY A. GOLDSTEIN**  
**Executive Director**  
**Energy Resources Division**  
**Department for Energy and Mining**  
**Delegate of the Minister for Energy and Mining**

Date: 22 January 2020



# Certificate of Registration on Change of Name

This is to certify that

**LATTICE ENERGY LIMITED**

**Australian Company Number 007 845 338**

did on the second day of December 2019 change its name to

**BEACH ENERGY (OPERATIONS) LIMITED**

**Australian Company Number 007 845 338**

The company is a public company.

The company is limited by shares.

The company is taken to be registered under the Corporations Act 2001 in South Australia and the date of commencement of registration is the ninth day of September, 1977.

Issued by the  
Australian Securities and Investments Commission  
on this second day of December 2019.

A handwritten signature in black ink that reads 'James Shipton'.

James Shipton  
Chair

CERTIFICATE

**Petroleum and Geothermal Energy Act 2000**  
**S.115**

**MEMORANDUM**

**PETROLEUM PRODUCTION LICENCES**

**PPLs 6, 7, 8, 9, 10, 11, 12, 13, 14, 15, 16, 17, 18, 19, 20, 22, 23, 24, 25, 26, 27, 29, 30, 31, 32, 33, 35, 36, 37, 38, 39, 40, 41, 42, 43, 44, 45, 46, 47, 48, 51, 52, 53, 54, 55, 56, 57, 58, 59, 60, 61, 63, 64, 65, 66, 67, 68, 69, 70, 72, 73, 74, 75, 76, 77, 78, 79, 80, 81, 83, 84, 86, 87, 88, 89, 90, 91, 92, 94, 95, 98, 99, 100, 101, 102, 103, 104, 105, 106, 107, 108, 109, 110, 111, 113, 114, 115, 116, 117, 118, 119, 120, 121, 122, 123, 124, 125, 126, 127, 128, 129, 130, 131, 132, 133, 134, 135, 136, 137, 138, 139, 140, 143, 144, 145, 146, 147, 148, 149, 150, 151, 152, 153, 154, 155, 156, 158, 159, 160, 161, 162, 163, 164, 165, 166, 167, 172, 174, 175, 176, 177, 178, 179, 180, 182, 187, 189, 190, 193, 194, 195, 196, 201, 228, 229, 230, 231, 232, 233, 234, 235, 236, 237 and 238**

**PIPELINE LICENCES**

**PLs 5, 9 and 15**

SA 2018-18

Notation of registrable dealing as evidenced by Deed of Variation dated 4 December 2015 between Santos Limited, Santos Petroleum Pty Ltd, Vamgas Pty Ltd, Santos (NARNL Cooper) Pty Ltd, Santos (BOL) Pty Ltd, Reef Oil Pty Ltd, Bridge Oil Developments Pty Limited, Basin Oil Pty Ltd, Alliance Petroleum Australia Pty Ltd, Origin Energy Resources Limited and Delhi Petroleum Pty Ltd is hereby entered on the public register.



**BARRY A. GOLDSTEIN**  
**Executive Director**  
**Energy Resources Division**  
**Department of the Premier and Cabinet**  
**Delegate of the Minister for Energy and Mining**

Date: 7 June 2018

Ref: 28/01/00045

**Petroleum and Geothermal Energy Act 2000**  
**S.115**

**MEMORANDUM**

**PETROLEUM RETENTION LICENCE**  
**PRL 106**

**PETROLEUM EXPLORATION LICENCES**  
**PELs 637 and 638**

**PETROLEUM PRODUCTION LICENCES**  
**PPLs 6, 7, 8, 9, 10, 11, 12, 13, 14, 15, 16, 17, 18, 19, 20, 22, 23, 24, 25, 26, 27, 29, 30, 31, 32, 33, 35, 36, 37, 38, 39, 40, 41, 42, 43, 44, 45, 46, 47, 48, 51, 52, 53, 54, 55, 56, 57, 58, 59, 60, 61, 63, 64, 65, 66, 67, 68, 69, 70, 72, 73, 74, 75, 76, 77, 78, 79, 80, 81, 83, 84, 86, 87, 88, 89, 90, 91, 92, 94, 95, 98, 99, 100, 101, 102, 103, 104, 105, 106, 107, 108, 109, 110, 111, 113, 114, 115, 116, 117, 118, 119, 120, 121, 122, 123, 124, 125, 126, 127, 128, 129, 130, 131, 132, 133, 134, 135, 136, 137, 138, 139, 140, 143, 144, 145, 146, 147, 148, 149, 150, 151, 152, 153, 154, 155, 156, 158, 159, 160, 161, 162, 163, 164, 165, 166, 167, 172, 174, 175, 176, 177, 178, 179, 180, 182, 187, 189, 190, 193, 194, 195, 196, 201, 228, 229, 230, 231, 232, 233, 234, 235, 236, 237 and 238**

**PIPELINE LICENCES**  
**PLs 2, 5, 9, 15 and 20**

1. Notation of change of company name:

From: Origin Energy Resources Limited  
To: Lattice Energy Limited

is hereby entered on the public registers.



**BARRY A. GOLDSTEIN**  
**Executive Director**  
**Energy Resources Division**  
**Department of the Premier and Cabinet**  
**Delegate of the Minister for Mineral Resources and Energy**

Date: 9 August 2017



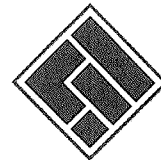

# Certificate of Registration on Change of Name

This is to certify that

**ORIGIN ENERGY RESOURCES LIMITED**

**Australian Company Number 007 845 338**

did on the twenty-ninth day of June 2017 change its name to

**LATTICE ENERGY LIMITED**

**Australian Company Number 007 845 338**

The company is a public company.

The company is limited by shares.

The company is taken to be registered under the Corporations Act 2001 in South Australia and the date of commencement of registration is the ninth day of September, 1977.

Issued by the  
Australian Securities and Investments Commission  
on this twenty-ninth day of June 2017.

Greg Medcraft  
Chairman

CERTIFICATE

**Petroleum and Geothermal Energy Act 2000  
S.115**

**MEMORANDUM**

**PETROLEUM PRODUCTION LICENCES**

**PPLs 6, 7, 8, 9, 10, 11, 12, 13, 14, 15, 16, 17, 18, 19, 20, 22, 23, 24, 25, 26, 27, 29, 30, 31, 32, 33, 35, 36, 37, 38, 39, 40, 41, 42, 43, 44, 45, 46, 47, 48, 51, 52, 53, 54, 55, 56, 57, 58, 59, 60, 61, 63, 64, 65, 66, 67, 68, 69, 70, 72, 73, 74, 75, 76, 77, 78, 79, 80, 81, 83, 84, 86, 87, 88, 89, 90, 91, 92, 94, 95, 98, 99, 100, 101, 102, 103, 104, 105, 106, 107, 108, 109, 110, 111, 113, 114, 115, 116, 117, 118, 119, 120, 121, 122, 123, 124, 125, 126, 127, 128, 129, 130, 131, 132, 133, 134, 135, 136, 137, 138, 139, 140, 143, 144, 145, 146, 147, 148, 149, 150, 151, 152, 153, 154, 155, 156, 158, 159, 160, 161, 162, 163, 164, 165, 166, 167, 172, 174, 175, 176, 177, 178, 179, 180, 182, 187, 189, 190, 193, 194, 195, 196, 201, 228, 229, 230, 231, 232, 233, 234, 235, 236, 237 and 238**

SA 2012-42      Notation of registrable dealing as evidenced by Royalty Deed dated 19 January 2012 between Delhi Petroleum Pty Ltd and Esso Australia Resources Pty Ltd is hereby entered on the public register.

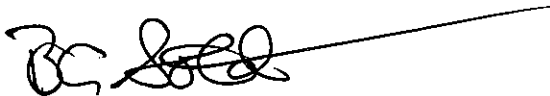

**BARRY A. GOLDSTEIN  
Executive Director  
Energy Resources Division  
Department for Manufacturing, Innovation, Trade, Resources and Energy  
Delegate of the Minister for Mineral Resources and Energy**

Date: 28 June 2012

Ref: various files

***Petroleum and Geothermal Energy Act 2000***  
**S.115**

**MEMORANDUM**

**PETROLEUM PRODUCTION LICENCES**

**PPLs 6, 7, 8, 9, 10, 11, 12, 13, 14, 15, 16, 17, 18, 19, 20, 22, 23, 24, 25, 26, 27, 29, 30, 31, 32, 33, 35, 36, 37, 38, 39, 40, 41, 42, 43, 44, 45, 46, 47, 48, 51, 52, 53, 54, 55, 56, 57, 58, 59, 60, 61, 63, 64, 65, 66, 67, 68, 69, 70, 72, 73, 74, 75, 76, 77, 78, 79, 80, 81, 83, 84, 86, 87, 88, 89, 90, 91, 92, 94, 95, 98, 99, 100, 101, 102, 103, 104, 105, 106, 107, 108, 109, 110, 111, 113, 114, 115, 116, 117, 118, 119, 120, 121, 122, 123, 124, 125, 126, 127, 128, 129, 130, 131, 132, 133, 134, 135, 136, 137, 138, 139, 140, 143, 144, 145, 146, 147, 148, 149, 150, 151, 152, 153, 154, 155, 156, 158, 159, 160, 161, 162, 163, 164, 165, 166, 167, 172, 174, 175, 176, 177, 178, 179, 180, 182, 187, 189, 190, 193, 194, 195, 196, 201, 228, 229, 230, 231, 232, 233, 234, 235, 236, 237 and 238**

**and**

**PIPELINE LICENCES**

**PLs 2, 5, 9 and 15**

SA 2011-15      Notation of registrable dealing as evidenced by Delhi Fixed and Floating Charge and Mortgage of JV Assets dated 29 September 2010 between Delhi Petroleum Pty Limited and Westpac Banking Corporation is hereby entered on the public register.



**BARRY A. GOLDSTEIN**  
**Director Petroleum and Geothermal**  
**Minerals and Energy Resources**  
**Primary Industries and Resources SA**  
**Delegate of the Minister for Mineral Resources**  
**Development**

Date: 15 February 2011

**Petroleum Act 2000**  
**S.115**

**MEMORANDUM**

Petroleum Production Licences (PPLs) 6, 7, 8, 9, 10, 11, 12, 13, 14, 15, 16, 17, 18, 19, 20, 22, 23, 24, 25, 26, 27, 28, 29, 30, 31, 32, 33, 34, 35, 36, 37, 38, 39, 40, 41, 42, 43, 44, 45, 46, 47, 48, 49, 50, 51, 52, 53, 54, 55, 56, 57, 58, 59, 60, 61, 63, 64, 65, 66, 67, 68, 69, 70, 71, 72, 73, 74, 75, 76, 77, 78, 79, 80, 81, 82, 83, 84, 85, 86, 87, 88, 89, 90, 91, 92, 93, 94, 95, 96, 97, 98, 99, 100, 101, 102, 103, 104, 105, 106, 107, 108, 109, 110, 111, 112, 113, 114, 115, 116, 117, 118, 119, 120, 121, 122, 123, 124, 125, 126, 127, 128, 129, 130, 131, 132, 133, 134, 135, 136, 137, 138, 139, 140, 141, 142, 143, 144, 145, 146, 147, 148, 149, 150, 151, 152, 153, 154, 155, 156, 157, 158, 159, 160, 161, 162, 163, 164, 165, 166, 167, 169, 170, 171, 172, 173, 174, 175, 176, 177, 178, 179, 180, 181, 182, 183, 184, 185, 186, 187, 188, 189, 190, 191, 192, 193, 194, 195, 196, 197, 198, 199 and Pipeline Licence (PL) 2.

1. Notation of change of company name –

From: Santos (NARNL Cooper) NL  
To: Santos (NARNL Cooper) Pty Ltd

is hereby entered on the public register of licences.



**C. D. COCKSHELL**  
**A/Director Petroleum and Geothermal**  
**Minerals and Energy Resources**  
**Primary Industries and Resources SA**  
**Delegate of the Minister for Mineral Resources**  
**Development**

Date: 9 May 2006

File: 27/2/4

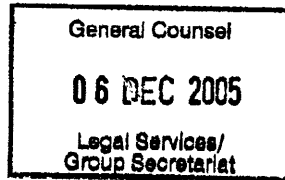

Form **242**

Santos Limited Attn: Graham Bollenhagen  
GPO Box 2455  
Adelaide SA 5001

Remove this top section if desired before framing

# Certificate of Registration on Change of Type and Conversion to a Proprietary Company



This is to certify that

**SANTOS (NARNL COOPER) NL**

**Australian Company Number 004 761 255**

on the first day of December 2005 converted to  
**a company limited by shares**  
and on the first day of December 2005 changed to  
a **proprietary** company.

The name of the company is now

**SANTOS (NARNL COOPER) PTY LTD**

**Australian Company Number 004 761 255**

The company is taken to be registered under the Corporations  
Act 2001 in Victoria and the date of commencement of  
registration is the twenty-first day of February, 1969.

Issued by the  
Australian Securities and Investments Commission  
on this first day of December, 2005.

A handwritten signature in black ink, appearing to read "Jeffrey Lucy".

Jeffrey Lucy  
Chairman

**CERTIFICATE**

**Petroleum Act 2000**  
**S.115**

**MEMORANDUM**

Petroleum Production Licences (PPLs) 6, 7, 8, 9, 10, 11, 12, 13, 14, 15, 16, 17, 18, 19, 20, 22, 23, 24, 25, 26, 27, 28, 29, 30, 31, 32, 33, 34, 35, 36, 37, 38, 39, 40, 41, 42, 43, 44, 45, 46, 47, 48, 49, 50, 51, 52, 53, 54, 55, 56, 57, 58, 59, 60, 61, 63, 64, 65, 66, 67, 68, 69, 70, 71, 72, 73, 74, 75, 76, 77, 78, 79, 80, 81, 82, 83, 84, 85, 86, 87, 88, 89, 90, 91, 92, 93, 94, 95, 96, 97, 98, 99, 100, 101, 102, 103, 104, 105, 106, 107, 108, 109, 110, 111, 112, 113, 114, 115, 116, 117, 118, 119, 120, 121, 122, 123, 124, 125, 126, 127, 128, 129, 130, 131, 132, 133, 134, 135, 136, 137, 138, 139, 140, 141, 142, 143, 144, 145, 146, 147, 148, 149, 150, 151, 152, 153, 154, 155, 156, 157, 158, 159, 160, 161, 162, 163, 164, 165, 166, 167, 169, 170, 171, 172, 173, 174, 175, 176, 177, 178, 179, 180, 181, 182, 183, 184, 185, 186, 187, 188, 189, 190, 191, 192, 193, 194, 195, 196, 197, 198, 199 and Pipeline Licence (PL) 2.

1. Notation of change of company name –

From: Novus Australia Resources NL  
To: Santos (NARNL Cooper) NL

is hereby entered on the public register of licences.



**BARRY A. GOLDSTEIN**  
**Director Petroleum**  
**Minerals and Energy Resources**  
**Primary Industries and Resources SA**  
**Delegate of the Minister for Mineral Resources**  
**Development**

Date: 13 January 2006

File: 27/2/4

Santos Limited Attn: Graham Bollenhagen  
GPO Box 2455  
Adelaide SA 5001

Remove this top section if desired before framing

## Certificate of Registration on Change of Name



This is to certify that

**NOVUS AUSTRALIA RESOURCES NL**

**Australian Company Number 004 761 255**

did on the twenty-ninth day of June 2005 change its name to

**SANTOS (NARNL COOPER) NL**

**Australian Company Number 004 761 255**

The company is a public company.

The company is a no liability company.

The company is taken to be registered under the Corporations Act 2001 in Victoria and the date of commencement of registration is the twenty-first day of February, 1969.

Issued by the  
Australian Securities and Investments Commission  
on this twenty-ninth day of June, 2005.

Jeffrey Lucy  
Chairman

CERTIFICATE

**Petroleum Act 2000**  
**S.115**

**MEMORANDUM**

**PETROLEUM PRODUCTION LICENCES (PPLs) 6, 7, 8, 9, 10, 11, 12, 13, 14, 15, 16, 17, 18, 19, 20, 22, 23, 24, 25, 26, 27, 28, 29, 30, 31, 32, 33, 34, 35, 36, 37, 38, 39, 40, 41, 42, 43, 44, 45, 46, 47, 48, 49, 50, 51, 52, 53, 54, 55, 56, 57, 58, 59, 60, 61, 63, 64, 65, 66, 67, 68, 69, 70, 71, 72, 73, 74, 75, 76, 77, 78, 79, 80, 81, 82, 83, 84, 85, 86, 87, 88, 89, 90, 91, 92, 93, 94, 95, 96, 97, 98, 99, 100, 101, 102, 103, 104, 105, 106, 107, 108, 109, 110, 111, 113, 114, 115, 116, 117, 118, 119, 120, 121, 122, 123, 124, 125, 126, 127, 128, 129, 130, 131, 132, 133, 134, 135, 136, 137, 138, 139, 140, 141, 142, 143, 144, 145, 146, 147, 148, 149, 150, 151, 152, 153, 154, 155, 156, 157, 158, 159, 160, 161, 162, 163, 164, 165, 166, 167, 169, 170, 171, 172, 173, 174, 175, 176, 177, 178, 179, 180, 181, 182, 183, 184, 185, 186, 187, 188, 189, 190, 191, 192, 193, 194, 195, 196, 197, 198, 199**

**and**

**PIPELINE LICENCES (PLs) 2, 5, 9 and 15**

1. Notation of receipt of Bank Guarantee dated 27 October 2005, is hereby entered on the commercial register.
2. Security is held to cover any event occurring in any licence operated by Santos Limited on behalf of the respective Cooper Basin Joint Ventures in South Australia.
3. Cash security held in respect of PPL 152 is hereby discharged to Santos Limited.
4. Bank Guarantees held in respect of the above referenced PLs and PPLs (excluding PPL 152) are hereby discharged to Santos Limited.



**BARRY A GOLDSTEIN**  
**Director Petroleum**  
**Minerals and Energy Division**  
**Primary Industries and Resources SA**  
**Delegate of the Minister for Mineral Resources**  
**Development**

Date: 23 November 2005



**Petroleum Act 2000**

S.115

**MEMORANDUM**

**PETROLEUM PRODUCTION LICENCES 6, 7, 8, 9, 10, 11, 12, 13, 14, 15, 16, 17, 18, 19, 20, 22, 23, 24, 25, 26, 27, 28, 29, 30, 31, 32, 33, 34, 35, 36, 37, 38, 39, 40, 41, 42, 43, 44, 45, 46, 47, 48, 49, 50, 51, 52, 53, 54, 55, 56, 57, 58, 59, 60, 61, 63, 64, 65, 66, 67, 68, 69, 70, 71, 72, 73, 74, 75, 76, 77, 78, 79, 80, 81, 82, 83, 84, 85, 86, 87, 88, 89, 90, 91, 92, 93, 94, 95, 96, 97, 98, 99, 100, 101, 102, 103, 104, 105, 106, 107, 108, 109, 110, 111, 113, 114, 115, 116, 117, 118, 119, 120, 121, 122, 123, 124, 125, 126, 127, 128, 129, 130, 131, 132, 133, 134, 135, 136, 137, 138, 139, 140, 141, 142, 143, 144, 145, 146, 147, 148, 149, 150, 151, 152, 153, 154, 155, 156, 157, 158, 159, 160, 161, 162, 163, 164, 165, 166, 167, 169, 170, 171, 172, 173, 174, 175, 176, 177, 178, 179, 180, 181, 182, 183, 184, 185, 186, 187, 188, 189, 190, 191, 192, 193, 194, 195, 196, 197, 198, 199**

**PIPELINE LICENCES 2, 5, 9 AND 15**

1. Notation of registrable dealing as evidenced by the following document is hereby entered on the Public Register;

- SA 2004-44 DPPL Security dated 21 May 2004 between Delhi Petroleum Pty Ltd and Westpac Banking Corporation.



**Paul Holloway**

Leader of the Government in the Legislative Council  
Minister for Industry, Trade and Regional Development  
Minister for Mineral Resources Development  
Minister for Small Business

Date: 23/7/04

**Petroleum Act 2000**

S.115(2)(e)

S.117(2)(b)

**MEMORANDUM**

**PETROLEUM PRODUCTION LICENCES (PPLs) 6, 7, 8, 9, 10, 11, 12, 13, 14, 15, 16, 17, 18, 19, 20, 22, 23, 24, 25, 26, 27, 28, 29, 30, 31, 32, 33, 34, 35, 36, 37, 38, 39, 40, 41, 42, 43, 44, 45, 46, 47, 48, 49, 50, 51, 52, 53, 54, 55, 56, 57, 58, 59, 60, 61, 63, 64, 65, 66, 67, 68, 69, 70, 71, 72, 73, 74, 75, 76, 77, 78, 79, 80, 81, 82, 83, 84, 85, 86, 87, 88, 89, 90, 91, 92, 93, 94, 95, 96, 97, 98, 99, 100, 101, 102, 103, 104, 105, 106, 107, 108, 109, 110, 111, 112, 113, 114, 115, 116, 117, 118, 119, 120, 121, 122, 123, 124, 125, 126, 127, 128, 129, 130, 131, 132, 133, 134, 135, 136, 137, 138, 139, 140, 141, 142, 143, 144, 145, 146, 147, 148, 149, 150, 151, 152, 153, 154, 155, 156, 157, 158, 159, 160, 161, 162, 163, 164, 165, 166, 167, 169, 170, 171, 172, 173, 174, 175, 176, 177, 178, 179, 180, 181, 182, 183, 184, 185, 186, 187, 188, 189, 190, 191, 192, 193, 194, 195, 196, 197, 198 and 199**

- 1 Pursuant to sections 115(2)(e) and 117(2)(b) of the *Petroleum Act 2000*, notation is hereby entered on the public and commercial register for each of the abovementioned PPLs, that the register created under the then *Petroleum Act 1940*, relative to Petroleum Exploration Licences 5 and 6, which expired on 27 February 1999, is adopted as part of the commercial register for each of the above said PPLs

Dated: 7 May 2004

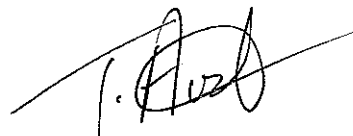

**T. AUST**  
**A/Director Petroleum**  
**Minerals and Energy Division**  
**Primary Industries and Resources SA**  
**Delegate of the Minister for Mineral**  
**Resources Development**

**Petroleum Act 2000**  
**S.115**

**MEMORANDUM**

**PETROLEUM PRODUCTION LICENCES**

PPL's 6, 7, 8, 9, 10, 11, 12, 13, 14, 15, 16, 17, 18, 19, 20, 22, 23, 24, 25, 27, 28, 29, 30, 31, 32, 33, 34, 35, 36, 37, 38, 39, 40, 41, 42, 43, 44, 45, 46, 47, 48, 49, 50, 51, 52, 53, 54, 55, 56, 57, 58, 59, 60, 61, 63, 64, 65, 66, 67, 68, 69, 70, 71, 72, 73, 74, 75, 78, 79, 80, 81, 82, 83, 84, 85, 86, 87, 88, 89, 90, 91, 92, 93, 94, 95, 96, 97, 98, 99, 100, 101, 102, 103, 104, 105, 106, 107, 108, 109, 110, 111, 112, 113, 114, 115, 116, 117, 119, 120, 124, 126, 127, 128, 129, 130, 132, 133, 134, 135, 137, 138, 139, 140, 141, 143, 144, 145, 146, 148, 149, 150, 151, 153, 154, 155, 157, 159, 160, 161, 162, 163, 164, 165, 166, 169, 170, 171, 172, 173, 174, 175, 176, 177, 178, 179, 180, 181, 183, 184, 185, 186, 188, 189, 190, 192, 193, 195, 196, 198, 199;

And

**PIPELINE LICENCE**  
**PL 2**

1. Notation of change of company name –

From: Basin Oil NL  
To: Basin Oil Pty Ltd

is hereby entered on the public register of licences.

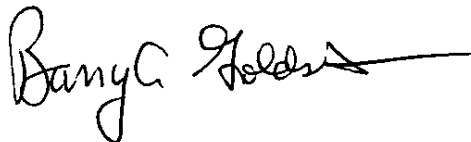

**BARRY A GOLDSTEIN**  
Director Petroleum  
Office of Minerals and Energy Resources  
Delegate of the Minister for Mineral Resources  
Development

Date: 15 October 2002

Form 242

FREEHILL HOLLINGDALE & PAGE  
AMP BUILDING  
22nd Fl  
140 ST Georges Terrace  
PERTH WA 6000

Remove this top section if desired before framing

# Certificate of Registration on Change of Type and Conversion to a Proprietary Company



This is to certify that

**BASIN OIL N.L.**

Australian Company Number 000 628 017

on the eighth day of June 2000 converted to  
a company limited by shares  
and on the eighth day of June 2000 changed  
to a proprietary company.

The name of the company is now

**BASIN OIL PTY LTD**

Australian Company Number 000 628 017

The company is taken to be registered as a company  
under the Corporations Law of New South Wales.

CERTIFICATE

Issued by the  
Australian Securities and Investments Commission  
on this eighth day of June, 2000.

Alan Cameron  
Chairman

**M E M O R A N D U M**

**PETROLEUM ACT 1940**

**SECTION 44**

**PETROLEUM EXPLORATION LICENCES NOS. 27, 32, 57, 66 AND 72  
PETROLEUM PRODUCTION LICENCES NOS. 6 TO 20, 22 TO 61 AND 63 TO 168  
PIPELINE LICENCES 2, 5, 9 AND 10**

Receipt of the following document is hereby entered onto the Petroleum Register.

- Certificate of Registration on Change of Name dated 24 February 2000.  
Boral Energy Resources Ltd is now known as Origin Energy Resources Ltd.



**J S ZABROWARNY  
MANAGER PETROLEUM LICENSING AND ROYALTIES**

13 March 2000

24/02/00

14:37

+61 8 8223 4405

NO. 462 · 004

User: MARKK

Host: BETA1.oca.boral.com.au

Class: Job: MARKK\_TRLRP

CLAYTON UTZ  
1 O'Connell Street  
SYDNEY NSW 2000

Remove this top section if desired before printing

## Certificate of Registration on Change of Name

This is to certify that

**BORAL ENERGY RESOURCES LIMITED**

Australian Company Number 007 845 338

did on the twenty-fourth day of February 2000 change its name to

**ORIGIN ENERGY RESOURCES LIMITED**

Australian Company Number 007 845 338

The company is a public company.

The company is limited by shares.

The company is taken to be registered as a company  
under the Corporations Law of South Australia.

Issued by the  
Australian Securities and Investments Commission  
on this twenty-fourth day of February, 2000.



Alan Cameron  
Chairman



CERTIFICATE

# MEMORANDUM

Section 44, Petroleum Act 1940

PETROLEUM PRODUCTION LICENCES 6 to 20,  
22 to 61, 63 to 140, 142 to 167

PIPELINE LICENCE No. 2

Receipt of the following document is hereby entered onto the Petroleum Register.

- Certificate of Registration on Change of Name dated 6 October 1999.  
Gulf (Aust) Resources NL is now known as Novus Australia Resources NL.



J S Zabrowarny  
Manager, Petroleum Licensing and Royalties

10 December 1999

NOVUS PETROLEUM LIMITED  
Level 9  
321 Kent Street  
SYDNEY NSW 2000

Remove this top section if desired before printing

## Certificate of Registration on Change of Name



This is to certify that

**GULF (AUST) RESOURCES N.L.**

Australian Company Number 004 761 255

did on the sixth day of October 1999 change its name to

**NOVUS AUSTRALIA RESOURCES NL**

Australian Company Number 004 761 255

The company is a public company.

The company is a no liability company.

The company is taken to be registered as a company  
under the Corporations Law of Victoria.

Issued by the  
Australian Securities and Investments Commission  
on this sixth day of October, 1999.

Alan Cameron  
Chairman

CERTIFICATE



## GRANT OF PETROLEUM PRODUCTION LICENCE

Department of Primary Industries and Resources, 11 August 1999

 NOTICE is hereby given that pursuant to delegated powers dated 20 November 1997, *Gazetted* 4 December 1997, page 1526, the undermentioned Petroleum Production Licence has been granted under the provisions of the Petroleum Act 1940.

D. R. MUTTON, Chief Executive, Delegate of the Minister for Primary Industries, Natural Resources and Regional Development

| No. of Licence | Licensees  | Locality  | Date of Expiry   | Area in km <sup>2</sup> | Reference   |
|----------------|--|---|------------------|-------------------------|-------------|
| 146            | SANTOS Ltd<br>Delhi Petroleum Pty Ltd<br>Boral Energy Resources Ltd<br>Vamgas Pty Ltd<br>Gulf (Aust) Resources NL<br>Alliance Petroleum Australia Pty Ltd<br>Reef Oil Pty Ltd<br>Santos Petroleum Pty Ltd<br>Bridge Oil Developments Pty Ltd<br>Santos (BOL) Pty Ltd<br>Basin Oil NL | Balcaminga (MEI) Field in the Cooper Basin of South Australia | 31 December 2019 | 9.66                    | SR.28.1.255 |

*Description of the Area*

All that part of the State of South Australia bounded as follows: commencing at a point being the intersection of latitude 27°33'35"S and longitude 140°21'30"E, thence east to longitude 140°22'30"E, south to latitude 27°34'10"S, west to longitude 140°22'20"E, south to latitude 27°34'30"S, west to longitude 140°22'10"E, south to latitude 27°34'40"S, west to longitude 140°22'00"E, south to latitude 27°34'55"S, west to longitude 140°21'50"E, south to latitude 27°35'05"S, west to longitude 140°21'40"E, south to latitude 27°35'25"S, west to longitude 140°21'20"E, south to latitude 27°35'40"S, west to longitude 140°19'35"E, north to latitude 27°35'25"S, west to longitude 140°19'25"E, north to latitude 27°35'15"S, west to longitude 140°19'20"E, north to latitude 27°35'00"S, east to longitude 140°21'00"E, north to latitude 27°34'00"S, east to longitude 140°21'30"E, and north to the point of commencement, all the within latitudes and longitudes being geodetic and expressed in terms of the Australian Geodetic Datum as defined on p. 4984 of *Commonwealth Gazette* number 84 dated 6 October 1966, except those latitudes and longitudes underlined which are expressed in terms of Clarke 1858 Spheroid (Transverse Mercator Projection).

## GRANT OF PETROLEUM PRODUCTION LICENCE

Department of Primary Industries and Resources, 11 August 1999

 NOTICE is hereby given that pursuant to delegated powers dated 20 November 1997, *Gazetted* 4 December 1997, page 1526, the undermentioned Petroleum Production Licence has been granted under the provisions of the Petroleum Act 1940.

D. R. MUTTON, Chief Executive, Delegate of the Minister for Primary Industries, Natural Resources and Regional Development

| No. of Licence | Licensees   | Locality   | Date of Expiry | Area in km <sup>2</sup> | Reference   |
|----------------|---|--|----------------|-------------------------|-------------|
| 147            | SANTOS Ltd<br>Delhi Petroleum Pty Ltd<br>Boral Energy Resources Ltd<br>Vamgas Pty Ltd<br>Gulf (Aust) Resources NL | Balcaminga (PE) Field in the Cooper Basin of South Australia | 10 August 2020 | 3.32                    | SR.28.1.279 |

*Description of the Area*

All that part of the State of South Australia bounded as follows: commencing at a point being the intersection of latitude 27°34'10"S and longitude 140°20'00"E, thence east to longitude 140°21'00"E, south to latitude 27°35'00"S, west to longitude 140°19'20"E, north to latitude 27°34'30"S, east to longitude 140°19'40"E, north to latitude 27°34'20"S, east to longitude 140°20'00"E, and north to the point of commencement, all the within latitudes and longitudes being geodetic and expressed in terms of the Australian Geodetic Datum as defined on p. 4984 of *Commonwealth Gazette* number 84 dated 6 October 1966, except those latitudes and longitudes underlined which are expressed in terms of Clarke 1858 Spheroid (Transverse Mercator Projection).

**MEMORANDUM**

**PETROLEUM PRODUCTION LICENCE NO 146**

1. This licence granted on 11/8/1999 is hereby entered on the Petroleum Register.
2. A security in the form of a \$15,000 bank guarantee has been lodged with respect to this licence.
3. Interests in the licence are as follows:

|  | %     |
|--|-------|
| • Santos Ltd                           | 40.70 |
| • Delhi Petroleum Pty Ltd              | 20.21 |
| • Boral Energy Resources Ltd           | 13.19 |
| • Vamgas Pty Ltd                       | 8.51  |
| • Gulf (Aust) Resources NL             | 4.75  |
| • Bridge Oil Developments Pty Ltd      | 3.99  |
| • Alliance Petroleum Australia Pty Ltd | 3.97  |
| • Basin Oil NL                         | 2.10  |
| • Reef Oil Pty Ltd                     | 1.97  |
| • Santos Petroleum Pty Ltd             | 0.40  |
| • Santos (BOL) Pty Ltd                 | 0.21  |

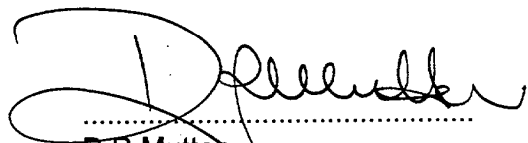

.....  
**D R Mutton**  
**CHIEF EXECUTIVE**  
**DEPT OF PRIMARY INDUSTRIES AND**  
**RESOURCES SA**

Delegate of the Minister for Primary  
Industries, Natural Resources and  
Regional Development

**SOUTH AUSTRALIA  
PETROLEUM ACT 1940**

and

**COOPER BASIN (RATIFICATION) ACT 1975  
PETROLEUM PRODUCTION LICENCE NO. 146**

COMMISSIONER OF STATE REGISTRATION

S.A. STAMP DUTY

FORM 1 of 13

12/08/1999 15:33:09

EXEMPT / NOT CHARGEABLE

I, DENNIS RAY MUTTON, Chief Executive, Department of Primary Industries and Resources (CE) in the State of South Australia pursuant to the provisions of the Petroleum Act, 1940 and the Cooper Basin (Ratification) Act 1975 and all other enabling powers, for and on behalf of Robert Gerard Kerin, Minister for Primary Industries, Natural Resources and Regional Development ('Minister'), pursuant to delegation dated 20 November 1997, (refer Government Gazette dated 4 December 1997 page 1526), HEREBY GRANT JOINTLY to:

- **SANTOS LIMITED**, A.C.N. 007 550 923 of Level 29, 91 King William Street, Adelaide, South Australia,
- **DELHI PETROLEUM PTY LTD**, A.C.N. 007 854 686 of C/- Esso Australia Ltd, 12 Riverside Quay, Southbank, Victoria,
- **BORAL ENERGY RESOURCES LIMITED**, A.C.N. 007 845 338 of 60 Hindmarsh Square, Adelaide, South Australia,
- **VAMGAS PTY LTD**, A.C.N. 006 245 110 of Level 29, 91 King William Street, Adelaide, South Australia,
- **GULF (AUST) RESOURCES NL**, A.C.N. 004 761 255 of 14th Floor, 216 St George's Terrace, Perth, Western Australia,
- **ALLIANCE PETROLEUM AUSTRALIA PTY LTD**, A.C.N. 004 559 951 of Level 29, 91 King William Street, Adelaide, SA,
- **REEF OIL PTY LTD**, A.C.N. 000 646 800 of Level 29, 91 King William Street, Adelaide, SA,
- **SANTOS PETROLEUM PTY LTD**, A.C.N. 000 146 369 of Level 29, 91 King William Street, Adelaide, SA,
- **BRIDGE OIL DEVELOPMENTS PTY LTD**, A.C.N. 001 152 049 of Level 29, 91 King William Street, Adelaide, SA,
- **SANTOS (BOL) PTY LTD**, A.C.N. 000 670 575 of Level 29, 91 King William Street, Adelaide, SA,
- **BASIN OIL NL**, A.C.N. 000 628 017 of Level 4, 828 Pacific Highway, Gordon, NSW.

a Petroleum Production Licence in respect of the area described hereunder:-

## TERMS AND CONDITIONS

1. The term of this licence is twenty-one (21) years commencing on and inclusive of the first day of January 1999 with the right, subject to carrying out adequately the obligations of the licence, to renewal from time to time on the same terms and conditions for further terms of twenty-one (21) years.
2. The licensees hereby covenant with the Minister that they will make payment of the yearly rent provided under the Petroleum Act 1940 and of the royalty referred to in the Cooper Basin (Ratification) Act 1975 and will subject to the provisions of the Cooper Basin (Ratification) Act 1975 comply with the provisions of the Petroleum Act 1940 and with all Regulations for the time being in force under that Act and with any directions given by the Minister, the Chief Executive of Primary Industries and Resources or any other person pursuant to that Act or the said Regulations.
3. The Minister hereby gives and records his consent to the grant by the licensees of one or more sub-licences pursuant to the provisions of the Cooper Basin (Ratification) Act 1975 in the form of or to the effect set out in the Schedule hereto.
4. It is hereby acknowledged and agreed that the licensees own and hold the following undivided interests respectively in and under this licence:-

|                  |                                 |          |
|------------------|---------------------------------|----------|
| Santos           | Forty point seven zero percent  | (40.70%) |
| Delhi            | Twenty point two one percent    | (20.21%) |
| Boral Energy     | Thirteen point one nine percent | (13.19%) |
| Vamgas           | Eight point five one percent    | (8.51%)  |
| Gulf             | Four point seven five percent   | (4.75%)  |
| Bridge Oil       | Three point nine nine percent   | (3.99%)  |
| Alliance         | Three point nine seven percent  | (3.97%)  |
| Basin            | Two point one zero percent      | (2.10%)  |
| Reef             | One point nine seven percent    | (1.97%)  |
| Santos Petroleum | Zero point four zero percent    | (0.40%)  |
| Santos (BOL)     | Zero point two one percent      | (0.21%)  |

**PROVIDED THAT** nothing in this Clause contained shall in any way affect or derogate from the rights, duties and liabilities of the licensees (as determined pursuant to the Indenture as defined in the Cooper Basin (Ratification) Act 1975 and the Petroleum Act 1940) to the Minister under this licence **AND PROVIDED FURTHER THAT** as between the licensees the undivided interests so owned and held by the licensees shall be subject to the provisions of a Joint Operating Agreement dated the 18th day of February 1970 to which the licensees are parties and as the same has been amended and as may hereafter be amended from time to time.

Signed by the Chief Executive,  
Department of Primary Industries and  
Resources at Adelaide

this ..... 11 ..... day of August 19 99

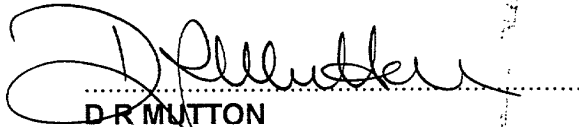

**D R MUTTON**  
**CHIEF EXECUTIVE**  
**Department of Primary Industries and**  
**Resources SA**  
**Delegate of the Minister for Primary**  
**Industries, Natural Resources**  
**and Regional Development**

**SIGNED, SEALED AND DELIVERED** )  
by the said **LICENSEES** at Adelaide )  
this ..... 11th ..... day of August ..... 1999..... )

Executed on behalf of **SANTOS LIMITED, ALLIANCE** )  
**PETROLEUM AUSTRALIA PTY LTD, REEF OIL** )  
**PTY LTD, SANTOS (BOL) PTY LTD, BRIDGE OIL** )  
**DEVELOPMENTS PTY LTD, SANTOS PETROLEUM** )  
**PTY LTD and VAMGAS PTY LTD,** respectively by being )  
**SIGNED, SEALED AND DELIVERED** by its duly )  
authorised Attorney under Power of Attorney who )  
hereby states that he has received no notice of )  
revocation of the Power of Attorney affecting such )  
appointment, in the presence of: )

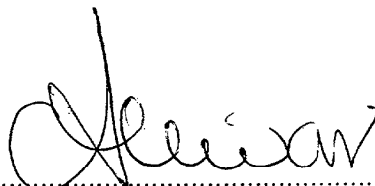
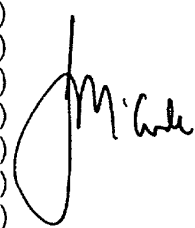
  
.....  
(Witness)

EXECUTED for and on behalf of  
DELHI PETROLEUM PTY LTD  
by its duly authorised attorney  
in the presence of:

)  
)  
)  
)

Signature of Attorney

Signature of Witness

IAN WILLIAM ANGUS  
Name of Attorney

MAREE HINCKES  
Name of Witness

THE COMMON SEAL of BORAL ENERGY  
RESOURCES LIMITED was hereunto  
affixed in the presence of:

)  
)  
)

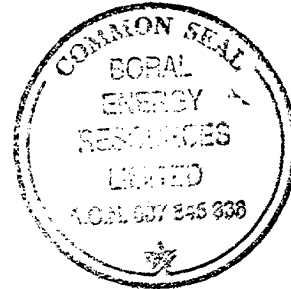

(Director)

(Secretary)

THE COMMON SEAL OF GULF (AUST)  
RESOURCES NL was hereunto affixed in  
the presence of:

)  
)

Signed under Power of Attorney  
Dated 30th July 1999  
by D.R. Whitby for and on  
behalf of Gulf (Aust)  
Resources N.L.

(Director) Attorney

Witness (Secretary)

THE COMMON SEAL of BASIN OIL  
NL was hereunto affixed in the presence of:

)  
)  
)

.....  
(Director)

.....  
(Secretary)

EXECUTED for and on behalf of  
DELHI PETROLEUM PTY LTD  
by its duly authorised attorney  
in the presence of:

Signature of Attorney

Signature of Witness

Name of Attorney

Name of Witness

THE COMMON SEAL of BORAL ENERGY  
RESOURCES LIMITED was hereunto  
affixed in the presence of:

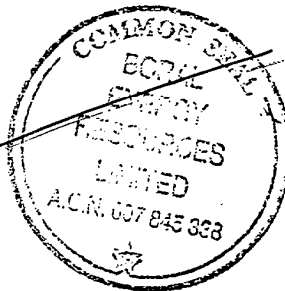

*[Signature]*  
(Director)

*[Signature]*  
(Secretary)

THE COMMON SEAL OF GULF (AUST)  
RESOURCES NL was hereunto affixed in  
the presence of:

(Director)

(Secretary)

THE COMMON SEAL of BASIN OIL  
NL was hereunto affixed in the presence of:

(Director)

(Secretary)

Executed on behalf of Basin Oil N.L. by being signed sealed and delivered by its duly authorised Attorney Rosinda Meunice Mcnamara under Power of Attorney who hereby states that she has received no notice of revocation of the Power of Attorney affecting such appointment, in the presence of.

*[Signature]*  
witness

*[Signature]*

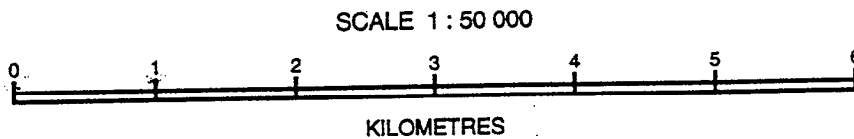
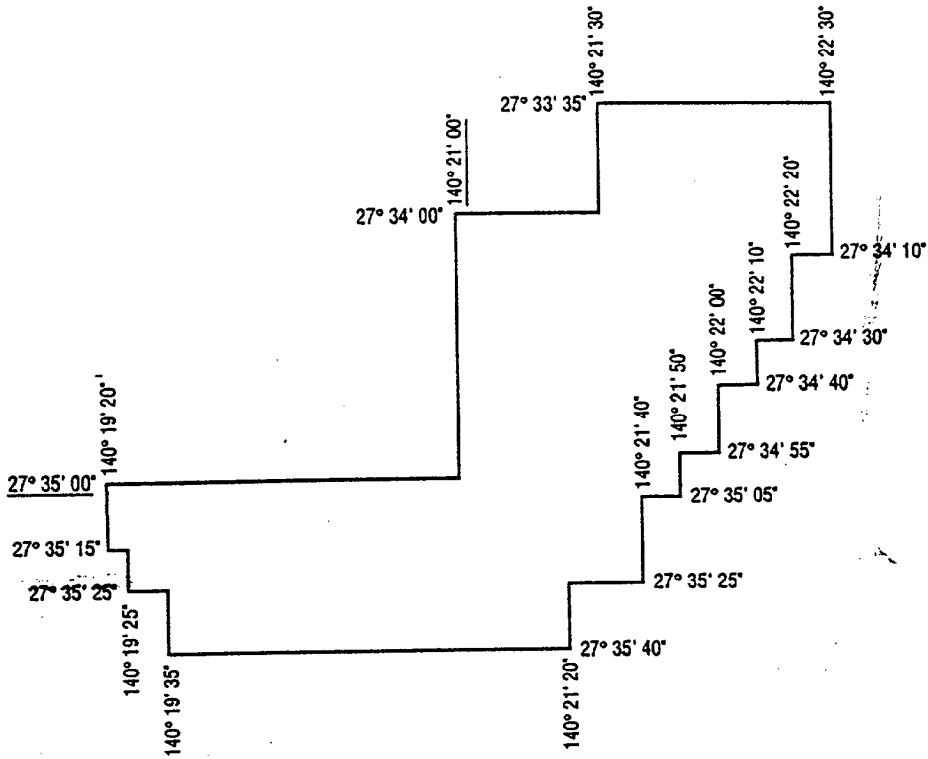

All the within latitudes and longitudes are geodetic and expressed in terms of the Australian Geodetic Datum as defined on page 4984 of Commonwealth Gazette number 84 dated 6 October 1966, except those latitudes and longitudes underlined which are expressed in terms of Clarke 1858 Spheroid (Transverse Mercator Projection)

**SANTOS LTD. DELHI PETROLEUM PTY. LTD. BORAL ENERGY RESOURCES LTD.  
 VAMGAS PTY. LTD. GULF (AUST) RESOURCES N.L. BASIN OIL N.L. REEF OIL PTY. LTD.  
 ALLIANCE PETROLEUM AUSTRALIA PTY. LTD. BRIDGE OIL DEVELOPMENTS PTY. LTD.  
 SANTOS PETROLEUM PTY. LTD. SANTOS (BOL) PTY. LTD.**

**MERRIMELIA – INNAMINCKA BLOCK**

**BALCAMINGA FIELD**

**PETROLEUM PRODUCTION LICENCE NO. 146**



## SCHEDULE

### PETROLEUM PRODUCTION LICENCE NO. 146

#### DESCRIPTION OF AREA

All that part of the State of South Australia, bounded as follows:-

Commencing at a point being the intersection of latitude  $27^{\circ} 33' 35''$  S and longitude  $140^{\circ} 21' 30''$  E, thence east to longitude  $140^{\circ} 22' 30''$  E, south to latitude  $27^{\circ} 34' 10''$  S, west to longitude  $140^{\circ} 22' 20''$  E, south to latitude  $27^{\circ} 34' 30''$  S, west to longitude  $140^{\circ} 22' 10''$  E, south to latitude  $27^{\circ} 34' 40''$  S, west to longitude  $140^{\circ} 22' 00''$  E, south to latitude  $27^{\circ} 34' 55''$  S, west to longitude  $140^{\circ} 21' 50''$  E, south to latitude  $27^{\circ} 35' 05''$  S, west to longitude  $140^{\circ} 21' 40''$  E, south to latitude  $27^{\circ} 35' 25''$  S, west to longitude  $140^{\circ} 21' 20''$  E, south to latitude  $27^{\circ} 35' 40''$  S, west to longitude  $140^{\circ} 19' 35''$  E, north to latitude  $27^{\circ} 35' 25''$  S, west to longitude  $140^{\circ} 19' 25''$  E, north to latitude  $27^{\circ} 35' 15''$  S, west to longitude  $140^{\circ} 19' 20''$  E, north to latitude  $27^{\circ} 35' 00''$  S, east to longitude  $140^{\circ} 21' 00''$  E, north to latitude  $27^{\circ} 34' 00''$  S, east to longitude  $140^{\circ} 21' 30''$  E, and north to the point of commencement.

All the within latitudes and longitudes being geodetic and expressed in terms of the Australian Geodetic Datum as defined on p. 4984 of Commonwealth Gazette number 84 dated October 6, 1966, except those latitudes and longitudes underlined which are expressed in terms of Clarke 1858 Spheroid (Transverse Mercator Projection).

AREA 9.66 square kilometres approximately.

**THE SCHEDULE HEREINBEFORE REFERRED TO**

THIS DEED OF SUB-LICENCE made the \_\_\_\_\_ day of \_\_\_\_\_ 199

**BETWEEN:**

ALLIANCE PETROLEUM AUSTRALIA PTY. LTD. A.C.N. 004 559 951 whose registered office is situated at Level 29, Santos House, 91 King William Street, Adelaide in the State of South Australia (hereinafter sometimes called "Alliance" which expression where the context requires or permits shall include its successors and assigns);

**AND**

BASIN OIL N.L. A.C.N. 000 628 017 whose registered office is situated at Level 4, 828 Pacific Highway, Gordon in the State of New South Wales (hereinafter sometimes called "Basin" which expression where the context requires or permits shall include its successors and assigns);

**AND**

BORAL ENERGY RESOURCES LIMITED A.C.N. 007 845 338 whose registered office is situated at 60 Hindmarsh Square, Adelaide in the State of South Australia (hereinafter sometimes called "Boral" which expression where the context requires or permits shall include its successors and assigns);

**AND**

BRIDGE OIL DEVELOPMENTS PTY. LIMITED A.C.N. 001 152 049 whose registered office is situated at Level 29, Santos House, 91 King William Street, Adelaide in the State of South Australia (hereinafter sometimes called "BOD" which expression where the context requires or permits shall include its successors and assigns);

AND

DELHI PETROLEUM PTY. LTD. A.C.N. 007 854 686 whose registered office is situated at 12 Riverside Quay, Southbank in the State of Victoria (hereinafter sometimes called "Delhi" which expression where the context requires or permits shall include its successors and assigns);

AND

GULF (AUST) RESOURCES N.L. A.C.N. 004 761 255 whose registered office is situated at Level 14, London House, 216 St. Georges Terrace, Perth, in the State of Western Australia (hereinafter sometimes called "Gulf" which expression where the context requires or permits shall include its successors and assigns);

AND

REEF OIL PTY. LTD. A.C.N. 000 646 800 whose registered office is situated at Level 29, Santos House, 91 King William Street, Adelaide in the State of South Australia (hereinafter sometimes called "Reef" which expression where the context requires or permits shall include its successors and assigns);

AND

SANTOS LIMITED A.C.N. 007 550 923 whose registered office is situated at Level 29, Santos House, 91 King William Street, Adelaide in the State of South Australia (hereinafter sometimes called "Santos" which expression where the context requires or permits shall include its successors and assigns);

AND

SANTOS (BOL) PTY. LTD. A.C.N. 000 670 575 whose registered office is situated at Level 29, Santos House, 91 King William Street, Adelaide in the State of South Australia (hereinafter sometimes called "Santos (BOL)" which expression where the context requires or permits shall include its successors and assigns);

AND

SANTOS PETROLEUM PTY. LTD. A.C.N. 000 146 369 whose registered office is situated at Level 29, Santos House, 91 King William Street, Adelaide in the State of South Australia (hereinafter sometimes called "Santos Petroleum" which expression where the context requires or permits shall include its successors and assigns);

AND

VAMGAS PTY. LTD. A.C.N. 006 245 110 whose registered office is situated at Level 29, Santos House, 91 King William Street, Adelaide in the State of South Australia (hereinafter sometimes called "Vamgas" which expression where the context requires or permits shall include its successors and assigns);

the said companies being hereinafter collectively called "the Licensors" which expression where the context requires or permits shall include their respective successors and assigns);

OF THE ONE PART

AND

the said companies being hereinafter collectively called "the Licensees" which expression where the context requires or permits shall include their respective successors and assigns);

OF THE OTHER PART

WHEREAS:-

- A. The Licensors are the holders of Petroleum Production Licence No. [DATE OF LICENCE] granted by the Minister for Primary Industries and Resources of the State of South Australia pursuant to the powers in the *Petroleum Act 1940* and the *Cooper Basin (Ratification) Act 1975* over certain land in the State of South Australia as more particularly described in the said Petroleum Production Licence No. [ ] .
- B. The Licensees are parties to an agreement made as of the 1st day of January 1975 known as the South Australian Cooper Basin Unit Agreement (hereinafter and as the same has been and may hereafter be amended from time to time referred to as "the Unit Agreement") relating inter alia to the development and production of petroleum from that sub-surface portion of the area comprised in the said Petroleum Production Licence No. [ ] as the same is more particularly described in the Schedule hereto.
- C. The Licensors with the consent of the Minister for Primary Industries and Resources of the State of South Australia have agreed to grant and the Licensees have agreed to accept a sub-licence to exercise the rights specified in Clause 1 hereof upon the conditions specified in Clauses 2, 3, 4 and 5 hereof.

NOW THIS DEED WITNESSETH AS FOLLOWS:-

- 1. The Licensors with the consent of the Minister for Primary Industries and Resources of the State of South Australia hereby grant to each of the Licensees severally the

exclusive right for a period of twenty-one (21) years commencing and inclusive of the First day of January [YEAR] (with the right of renewal hereinafter contained) subject to the provisions of this Deed of Sub-Licence to:-

- (a) conduct operations for the appraisal and production of petroleum from such sub-surface portion of the area comprised in the said Petroleum Production Licence No. [ ] as is more particularly described in the Schedule hereto (hereinafter referred to as "the Unitized Zone") and subject to Clause 2 hereof to own all petroleum extracted or released therefrom; and
  - (b) construct and maintain upon the land comprised in the said Petroleum Production Licence No. [ ] all such facilities as the Licensors are entitled to construct and maintain thereon pursuant to Section 33 of the *Petroleum Act 1940* or the *Cooper Basin (Ratification) Act 1975* (or both) of the State of South Australia and as are necessary from time to time for the full enjoyment of the rights granted pursuant to Clause 1(a) hereof.
2. Each of the Licensees hereby expressly acknowledges, covenants and agrees with the Licensors and with each of the other Licensees that in the exercise of exclusive rights granted pursuant to Clause 1 hereof each Licensee shall at all times act subject to and in accordance with the provisions of the Unit Agreement (and in particular to the provisions of Clause 13.01 thereof which refers to an overriding royalty in favour of Santos) and that such rights shall entitle each Licensee to extract or release from the Unitized Zone so much of the petroleum within the Unitized Zone as such Licensee is entitled to from time to time in accordance with its Gas Unit Participation, Ethane Unit Participation, Propane Unit Participation, Butane Unit Participation, Condensate Unit Participation, Crude Oil Unit Participation and its Additional Plant Products Unit Participation or Participations in accordance with the provisions of the Unit Agreement.
3. The Licensees hereby jointly and severally covenant with the Licensors that they will make payment in accordance with the Unit Agreement, as amended, of the royalty

referred to in the *Cooper Basin (Ratification) Act 1975* in respect to the production referred to in Clause 2 hereof and subject to the provisions of the *Cooper Basin (Ratification) Act 1975* make payment in accordance with the Unit Agreement of the yearly rent provided under the said *Petroleum Act 1940* and will subject as aforesaid comply with the provisions of the said *Petroleum Act 1940* and with all Regulations for the time being in force under that Act and with any directions given by the Minister, the Director-Petroleum Group for Primary Industries and Resources or any other person pursuant to that Act or the said Regulations and the Licensees hereby further jointly and severally covenant with the Licensors not to do any act or thing or make any omission which would cause the Licensors to be in breach or default of the provisions of the said Petroleum Production Licence No. [ ] or of the provisions of the said *Petroleum Act 1940* or of any Regulation for the time being in force under that Act or with any direction given by the Minister, the Director-Petroleum Group for Primary Industries and Resources or any other person pursuant to that Act or the said Regulations.

4. Subject to the due compliance by the Licensees with their obligations under this Deed of Sub-Licence the Licensors hereby covenant with the Licensees:-
- (a) to perform the covenants and obligations on the part of the Licensors contained in the said Petroleum Production Licence No. [ ];
  - (b) that for such period as the same is required for the purpose of the Unit Agreement, to exercise their rights of renewal pertaining to the said Petroleum Production Licence No. [ ]; and
  - (c) to renew the provisions of this Deed of Sub-Licence on the same terms and conditions during any renewed term of the said Petroleum Production Licence No. [ ] for such period as aforesaid.
5. The rights of the Licensees or any of them granted pursuant to the foregoing provisions of this Deed of Sub-Licence shall not be sold assigned transferred leased sub-let mortgaged pledged charged encumbered or otherwise disposed of other than subject to

and in accordance with the provisions of Article XV of the Unit Agreement and subject to Section 42 of the said *Petroleum Act 1940* and Clause 14.2 of the Indenture as defined in the *Cooper Basin (Ratification) Act 1975*.





**THE SCHEDULE**  
(“Description of Unitized Zones”)

IN WITNESS WHEREOF the Parties hereto sign seal and deliver the foregoing presents and have hereunto set their respective hands and seals as of the day and year first above written.

Executed on behalf of )  
ALLIANCE PETROLEUM AUSTRALIA )  
PTY. LTD., BRIDGE OIL )  
DEVELOPMENTS PTY. LIMITED, REEF )  
OIL PTY. LTD., SANTOS LIMITED, )  
SANTOS (BOL) PTY. LTD., SANTOS )  
PETROLEUM PTY. LTD. and VAMGAS )  
PTY. LTD., respectively by being SIGNED )  
SEALED AND DELIVERED by its duly )  
authorised Attorney under Power of Attorney )  
who hereby states that he has received no )  
notice of revocation of the Power of Attorney )  
effecting such appointment, in the presence of: )

.....  
(Witness)

.....  
(Attorney)

THE COMMON SEAL of )  
BASIN OIL N.L. was )  
hereunto affixed in the presence of: )

.....  
Secretary

.....  
Director

THE COMMON SEAL of )  
BORAL ENERGY RESOURCES )  
LIMITED was hereunto affixed in the )  
presence of: )

.....  
Secretary

.....  
Director

EXECUTED for and on behalf of )  
DELHI PETROLEUM PTY. LTD. )  
by IAN WILLIAM ANGUS )  
its duly authorised Attorney in the presence of: )  
)

.....  
Witness

.....  
Delhi Petroleum Pty. Ltd.  
by its Attorney

THE COMMON SEAL of )  
GULF (AUST) RESOURCES N.L. )  
was hereunto affixed in the presence of: )

.....  
Secretary

.....  
Director

In accordance with Section 117 of the *Petroleum Act 2000* (Act) this document forms part of 'The Commercial Register'.

Section 118 of the Act provides for the following:

**Authority to search register**

(1) A person is entitled to have access to the material included in the commercial register, on payment of the prescribed inspection fee, if the access is authorised by—

- (a) a person who has a legal or equitable interest in the relevant licence or registered dealing; or
- (b) (b) the Minister.

(2) The Minister must not authorise access under subsection (1)(b) unless the Minister has consulted with the licensee to whom the material relates and is satisfied that access should be authorised in the public interest.

FOR FURTHER INFORMATION PLEASE CONTACT:

Department of State Development  
Energy Resources Division  
GPO Box 320,  
Adelaide SA 5001  
(08) 8463 3204